



ZSK TECHNICAL EMBROIDERY SYSTEMS  
A DIVISION OF ZSK STICKMASCHINEN

03/2019

# TECHNICAL EMBROIDERY SYSTEMS

MACHINES TO PLACE AND EMBROIDER WIRES, FIBERS, AND TUBES





ATTACHMENT BY EMBROIDERY IS  
ONE OF THE MOST ACCURATE AND  
EFFICIENT PRODUCTION METHODS.

## **ZSK TECHNICAL EMBROIDERY SYSTEMS**

### **MACHINES TO PLACE AND EMBROIDER FIBERS, WIRES, AND TUBES**

ZSK TECHNICAL EMBROIDERY SYSTEMS enable the use of new and innovative techniques that place and fix different media on textiles and other flexible carrier materials.

Media as wires, fibers, tubes, and optical fibers can be placed flexibly and will be secured strongly through embroidery techniques like the ZigZag stitch. Materials like polyamid, polyester, PPS or aramid are available as a embroiderable yarn. For products with special load requirements, yarns with a steel core can be used.

# METHODS

The different embroidery technologies developed by ZSK TECHNICAL EMBROIDERY SYSTEMS enable a wide scope of products, applications, and methodical procedures to be implemented for specific design goals and constraints.

## Examples

- Integration of wire into fabrics for heating and sensing (e.g. moisture, temperature, stretch) applications.
- Embroidery with conductive yarn to create textile electrodes for body signal monitoring (e.g. ECG) or electro stimulation (EMS or TENS) or embroidered connectors between electronic parts and textiles (conductive paths and connection pads).
- Placement with Technical Sequins<sup>+</sup> with LED or electronic chips. Automatic electrical connection obtained by embroidery with conductive threads.
- Production of near net shape composite preforms via Tailored Fiber Placement (TFP).
- Fixation of fibrous material like carbon, glass, basalt, aramid, natural, thermoplastic, ceramic fibers as well as metallic threads and PCL, PVA, PA, PP, PVDF on textile and flexible carrier material in complex shapes for e.g. local reinforcement or material combination.

To obtain these widely varied applications, ZSK TECHNICAL EMBROIDERY SYSTEMS provides configurable machinery with three different embroidery technologies. Each of these three technologies is obtained by a specific embroidery head and corresponding head (W-Head, F-Head and K-Head). These three different embroidery heads can be freely combined with each other on a single machine configured at the factory as a custom combination machine. Combination machines can include any variation of the W-Head for fiber or wire placement, the F-Head for standard embroidery, and the K-Head for textile electrodes.

## W-HEAD

ZSK's W-Head allows the laying of fibers, wires, and tubes onto a textile or a flexible carrier material. Embroidery technologies like the tailored wire, fiber, and tube placement can be realized with this technical head.



## F-HEAD

The F-Head is the most commonly used embroidery head often used for decorative embroidery. Stitches, like the double lock stitch or the satin stitch, belong to this category.

More functional applications can be realized with unconventional thread like conductive yarn.



## K-HEAD

The K-Head facilitates moss embroidery. With only one thread, the K-Head creates voluminous and soft surfaces.

In combination with conductive material, this technical embroidery head is ideal for producing high surface area sensors required for smart or medical textiles.



# W-HEAD

## PLACING WIRES

Currently, the placing of wire is an essential part in the production of many products from all spheres of life. Placing wire with ZSK's Technical Embroidery Systems is cost efficient, reliable, and environmentally friendly.

Today's most common application for laying of wires obtained by embroidery is the production of heated steering wheels with a market share of almost 100 % and heated car seats with a market share of over 10 %. Without any damage for the textile characteristics, especially the breathability and drapability, heating wires are easily placed on a textile substrate.

Placing wire with ZSK's Technical Embroidery Systems can be used for many other fields of application.

Applications include:

- Heated clothing
- Infrared heating systems
- Luminous textiles to improve security or comfort
- Embroidered RFID antennas
- Embroidered sensors on textiles for measurement of fill level, movement, temperature, moisture or stretch
- Embroidered circuits to integrate electrical functions

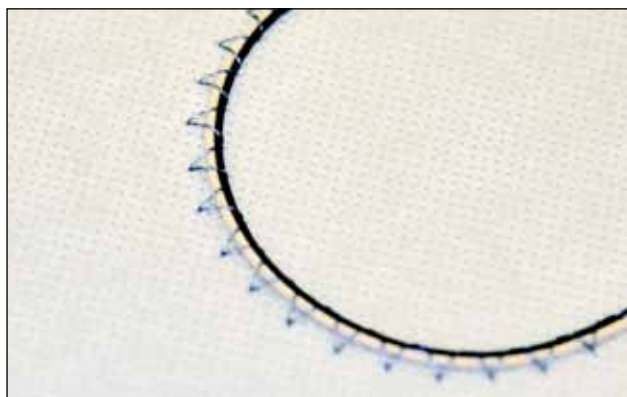

## PRINCIPLE OF W-HEAD EMBROIDERY

The material to be stitched is supplied by an active wire and fiber system to a guiding element close to the surface of the carrier material.

The media is finally fixed by embroidery by an upper thread with a ZigZag stitch.

The carrier material, fixed by the clamping and stretching system, is moved by the pantograph, enabling to lay e.g. rovings in any direction and quantity. The W-Head can process wires from 70 µm up to several mm thickness.

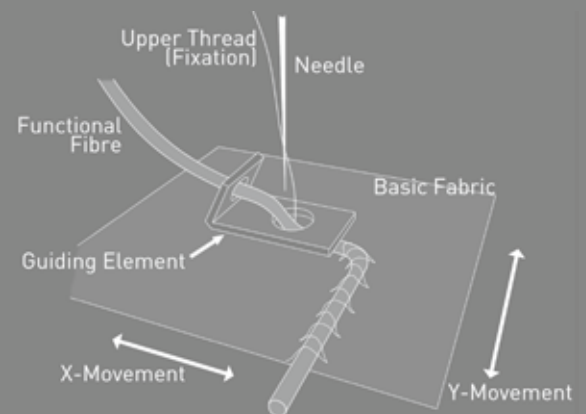

## ADVANTAGE OF SUPERIOR FLEXIBILITY

The essential difference between ZSK's Technical Embroidery Systems and other techniques like weaving, knitting, or even braiding create a significant advantage for many technical applications. Embroidery allows the absolutely free and flexible placing of the media at the 2-dimensional level of the carrier material. The placement is limited only by the physical characteristic of the media.

## PLACING FIBERS

An innovative technology to build up reinforcement fabrics is the free orientation, placing, and fixing of reinforcement materials by an embroidery machine. These techniques are already in practice in the production of near net shape preforms for composite parts. The application spectrum covers productions of components or textile structures which require the stitching of variable geometry ply stacks, where fabrics need to be reinforced locally, or where fabrics must be assembled.

One or more rovings are fixed to the base material by stitching.

During the process, the base material is moved by the pantograph, enabling placement of rovings in any direction and quantity up to a thickness of 7 mm.

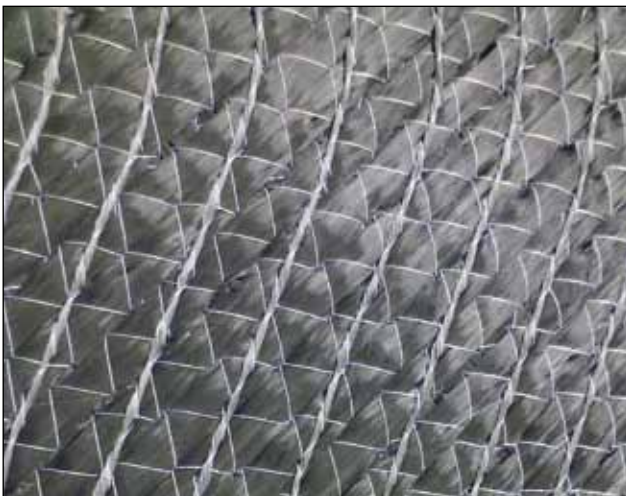

### TFP - Tailored Fiber Placement

Several fibrous materials like carbon, glass, basalt, aramid, natural, thermo-plastic, ceramic fibers, or metallic threads can be placed in a near net shape on a carrier material by TFP. Even the placement of different materials at the same time or one after another are easier implemented.

The high degree of freedom is an advantage for TFP preforms. The rovings can be placed exactly according to the distribution of forces within a structural component. Better and tailorable mechanical properties for less material usage.

Reproducibility speaks for itself and is accomplished by the following:

- Automatic preform production
- Low mass with high tolerance
- High dimensional accuracy
- Reliable identical laying roving

This cost effective process is driven by high stitching speed and multiple laying heads on a machine.

In comparison to other textile technologies, the loss of expensive materials like carbon fiber is kept to a minimum because of the near net shape production of the product. Accordingly, the problem of waste disposal is minimized.

## LAYING TUBES



### Tailored Tube Placement (TTP)

can be used to place tubes of several diameters on a textile structure.

Examples of use:

- Integration of tubes into textile reinforced concrete e.g. for heat exchange systems
- Suits and vests with tubes for cooling purposes
- Pipe systems for fluids of any kind applied to a textile structure or a flexible carrier material
- Ducts for electrical cables and connections as a cable harnesses applied to a textile structure or a flexible carrier material

# F-HEAD

The F-Head is the most commonly used embroidery technology, often referred to as standard embroidery. By using this standard technology with a satin- or running stitch with conductive threads, many applications for Wearables, E-Textiles and Smart Textiles are possible. Due to several available attachments like sequin-, cording- or Hot Air Cutting-devices the F-Head can be used for a wide variety of technical applications.

## Example: Conductive Yarn

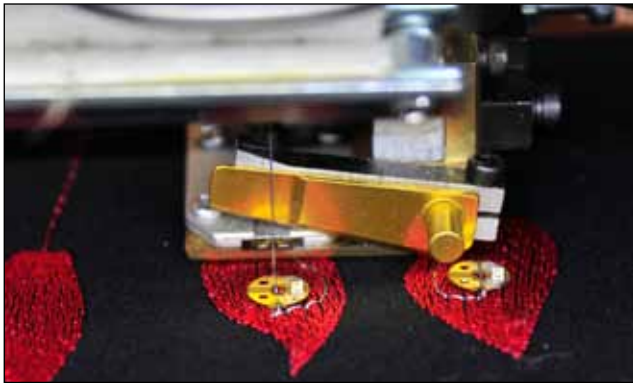

Embroidered LED Sequins (Functional Sequin Device - FSD)

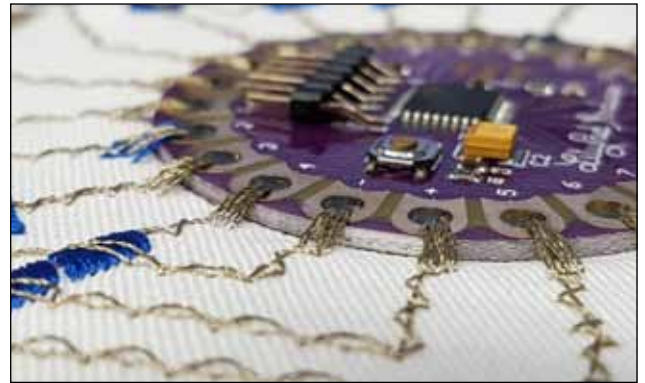

Embr. connections of main board, textile, conductive fiber

## PRINCIPLE OF F-HEAD EMBROIDERY

The loop forming at the so-called double lockstitch happens in several steps. The needle leads the embroidery yarn and the hook at the bobbin the lower bobbin thread.

First, the needle will pierce the textile material, at the same time the hook at the bobbin rotates and picks the bobbin thread.

Now the hook passes through the loop of the upper embroidery yarn. The needle leads back and the hook turns further on into the start position.

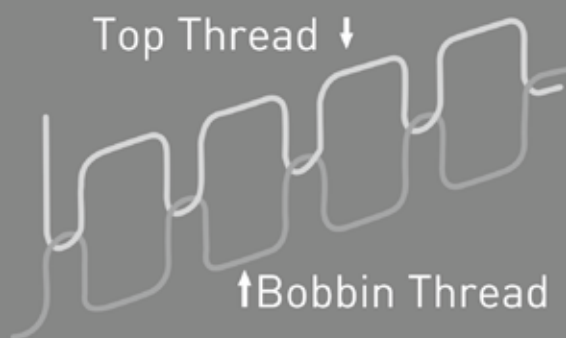

## Example: Embroidery of Wire

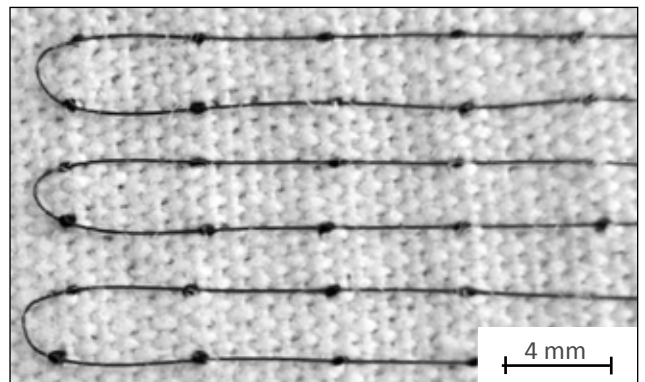

Embroidered nitinol wire (100  $\mu\text{m}$ ) [1]



Embroidered copper wire (70  $\mu\text{m}$ )

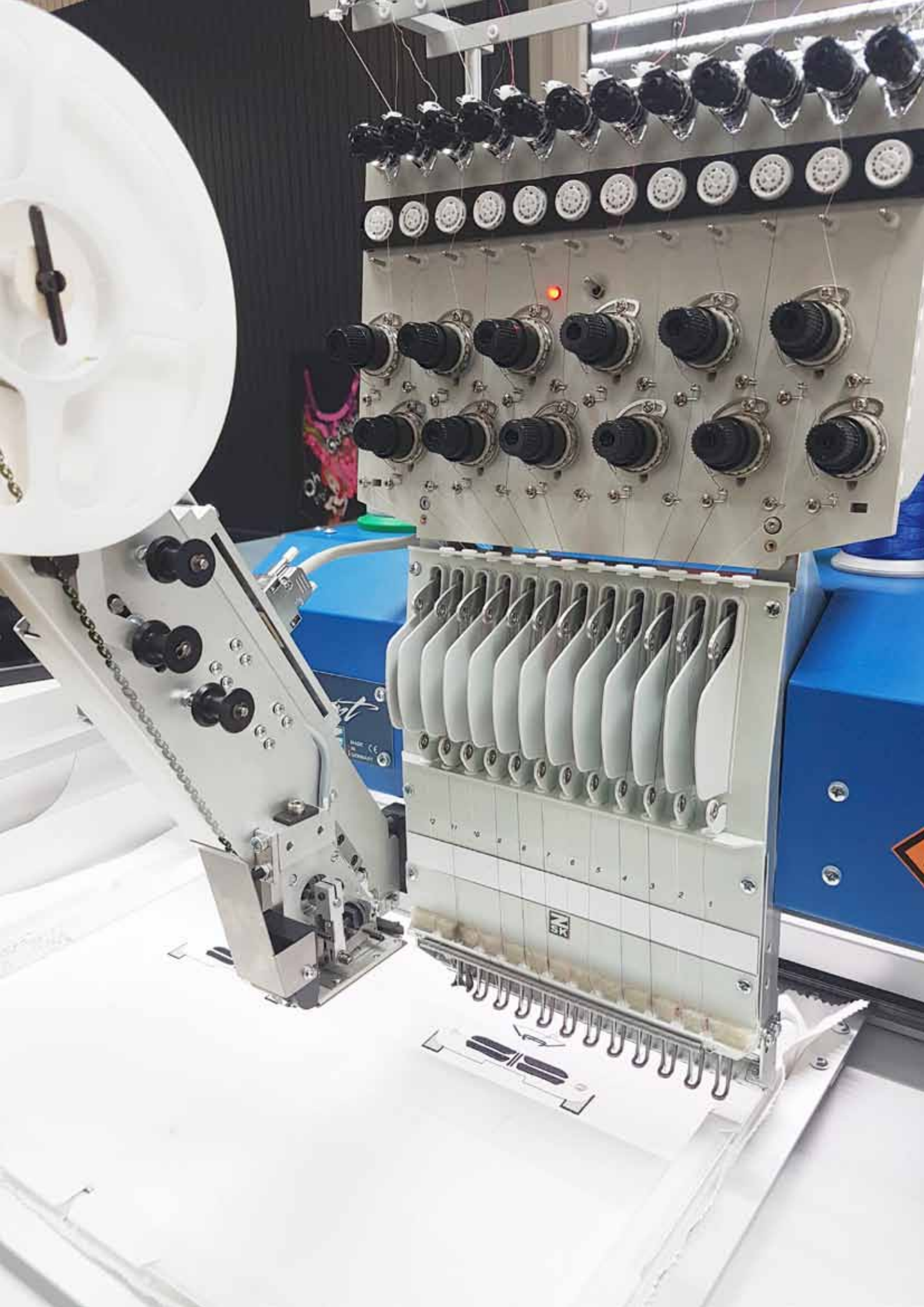

# K-HEAD



The K-Head creates moss embroidery. This single thread system creates loops at the surface of the carrier material. Voluminous surfaces will be generated by the compact placement of the stitches.

An actuator system with four separate single motor units supports the customization of parameters like the height of the loops, the presser foot or the inclined position to satisfy required needs.

Moss embroidery associated with electro conductive yarn is the ideal combination for products from the fields of Smart Textiles, Wearables and Medical Textiles. At these groups, textiles are equipped with additional functions like sensors or actors.

## Fields of Application

- Workaday clothes and workwear with integrated electrodes for ECG or EEG for e.g. long-term monitoring of at-risk patients or high-risk groups
- Custom-fit and high-individualized textile electrodes for e.g. electrophysiological techniques to stimulate dedicated muscle fibers
- Textiles like braces for electric stimulation therapy at sports, fitness, or medical rehabilitation



Moss embroidery - volume by compact stitches



Moss embroidery - close detail



## K-Head Supply System

ZSK Technical Embroidery Systems with K-Head offer a special supply system for the working thread which is positioned below the table. The system holds available six positions to provide fibers or conductive yarns with different characteristics.

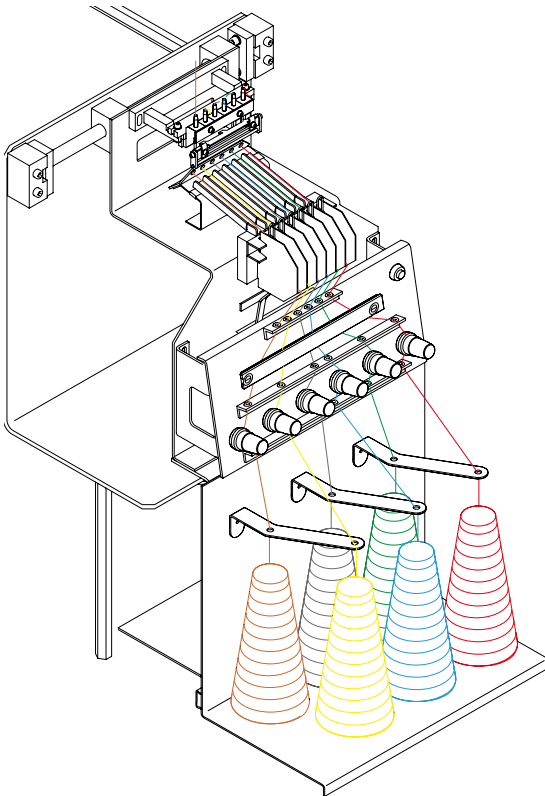

Graphical scheme of K-Head supply system



ANTELOPE.SUIT  
Moss embroidered electrodes for electrical muscle stimulation [2]

## PRINCIPLE OF K-HEAD EMBROIDERY

The moss embroidery machines are built differently than traditional embroidery machines however use a similar embroidery technique. Moss embroidery is created by a one-thread system. In this system, the needle goes through the carrier material (1) and pulls the thread out from under the needle, plate side up. Then, a loop is created by a rotary motion of the needle (2) on the upper side of the carrier material. Repeating this pattern produces a moss-like surface.

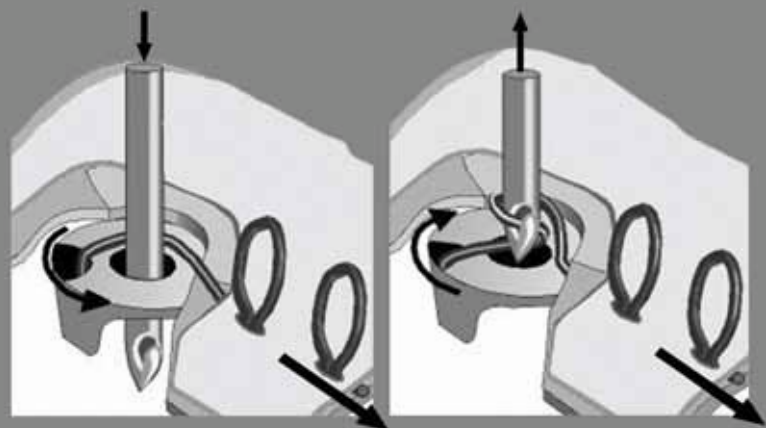

# OPTIONS

## 1 Active wire and fiber supply systems

Two supply systems can be installed on each laying head. Each supply system can take wire or fiber rolls up to 10kg. A new function implemented detects the end of supplied media.

## 2 Automatic unwinding function

The advantage to supply wires and fibers from large rolls has the disadvantage that the material has to be guided to the zig-zag layer by a system of pipes. That limits the possible rotation to 360 degrees. Because of this limitation wires could not be laid in spirals for example. ZSK has solved this problem by an automatic unwinding function!

## 3 Automatic change of different media

The change between two different media like two different wires or fibers and wires is fully automatic. (Patent pending.)

## 4 Pneumatic media trimmer

The pneumatic trimming system cuts all kind of fibers and even stronger wires.

## 5 Wire hit detection system

If a laid wire is hit by the needle the machine stops and indicates the affected laying head. The defective part can be marked to be removed. In many branches like in the production of car seat heating systems this function is obligatory.

## 6 Fast fiber laying

For large objects a fiber laying speed up to 5m per minute can be reached

## 7 HV-TFP

High Volume - Tailored Fiber Placement allows multiplying the productivity of ZSK technical embroidery systems by laying two or more rovings parallel at the same time.

## 8 Carbon protection for the electronics

All electronic devices of a ZSK technical embroidery machine can be protected against carbon dust.

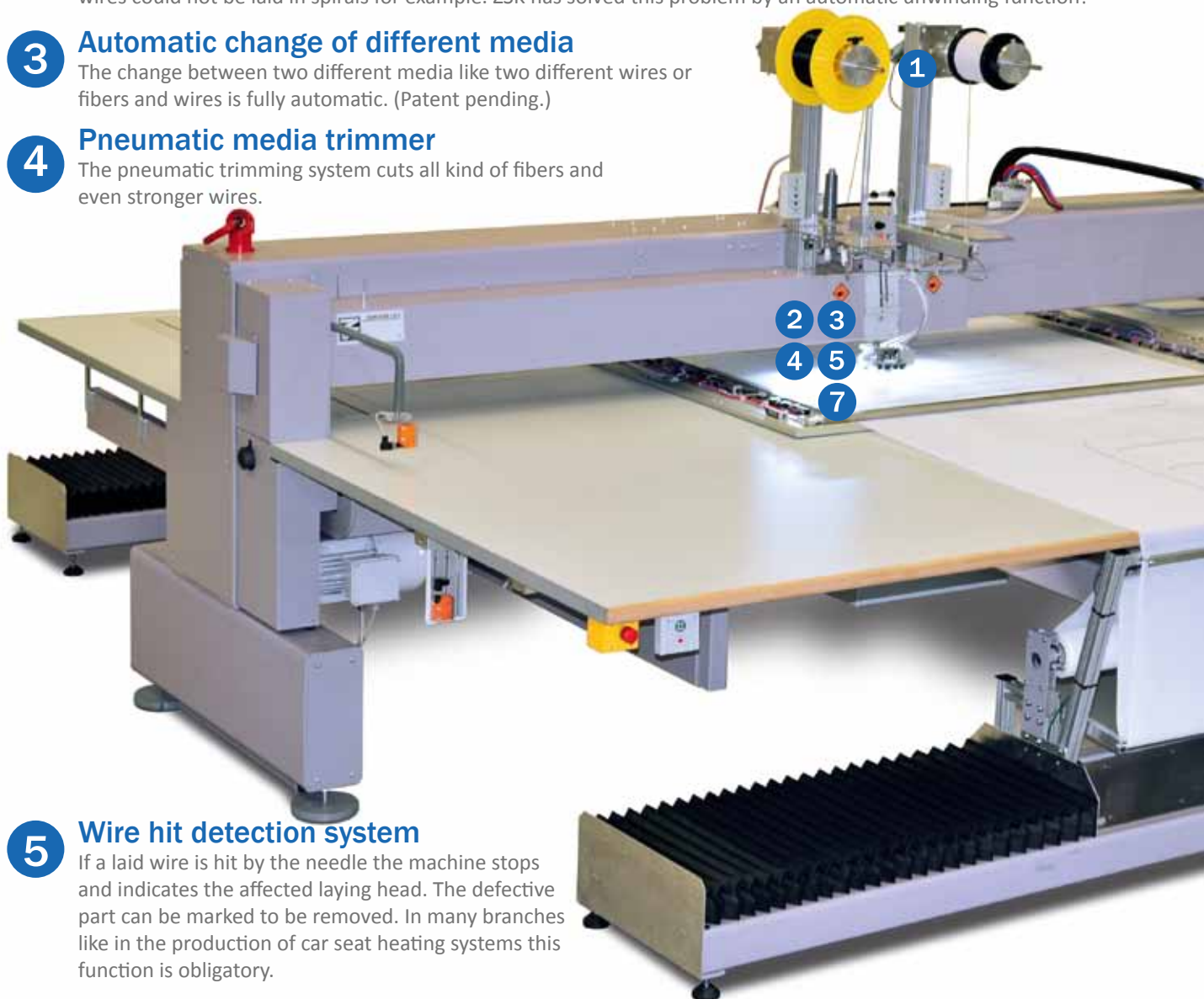

### Pneumatic clamping and stretching system **9**

A flat clamping and stretching system for the carrier material has been designed to automate .

### Automatic pull through system **10**

The carrier material is automatically pulled trough from roll to roll, back to front.

The system is available for all one head laying systems.

- Carrier material (woven, non woven, foils) up to 140cm wide is pulled automatically from back to front.
- The roll and re-roll stands follow the side movement of the pneumatic frame which allows to transport and re-clamp the carrier material in any position of the frame.
- Transporting and re-clamping is possible in back to front and vice versa direction in the middle of a wire laying design.
- The length of wire laying design is just limited to the length of the carrier material available on the roll.
- The unrestricted changing of the transporting direction of the carrier material allows to have the start and end of a wire for example at one point for easy connection.

### Semi automatic pull through system **11**

In case of multi head systems (up to 11 production areas) the carrier material is

pulled through from left to right. In connection with a pneumatic clamping and stretching system, the motor supported roll up loading time takes less then 2 minutes.

### Automatic bobbin changer **12**

The pneumatic bobbin changer for the under thread is equipped with a magazine for 7 full and one empty bobbin for up to 8 hours of running time.



**SGW 0100-1375-1200**

## ADVANTAGE HIGH LEVEL OF AUTOMATION

A significantly higher efficiency can be achieved by the production of technical textiles by using our advanced automation techniques. Quality, production output and labour costs will benefit on a high level from the options which are available for any machine of ZSK's technical embroidery systems.

# MACHINES

## Machine models and laying sizes for technical embroidery machines

### W - Head

Machine	No of Heads	Head Distance	Working Area Depth	Working Area Width	Machine Net Size (Length x Depth)
JCW 0100-500-700	1	-	600 mm 23.622"	400 mm 15,748"	1.570 x 1.730 mm 61.711" x 68.11"
<b>1</b> JGW 0100-650-700	1	-	600 mm - multiple 23.622" - multiple	650 mm 25.59"	2.000 x 1.800 mm 78.74" x 70.866"
JGW 0200-550D-700	2	550 mm 21.653"	600 mm 23.622"	2 x 550 mm / 1 x 1.100 mm 2 x 21.653" / 1 x 43.307"	3.440 x 1.840 mm 135.433" x 72.44"
CSGW 0100-1375-1000	1	-	900 mm 35.433"	1.300 mm 51,181"	4.100 x 2.460 mm 161.417" x 96.85"
<b>1</b> CSGW 0100-1375-1200	1	-	1.100 mm - multiple 43.307" - multiple	1.200 mm 47.244"	4.100 x 3.800 mm 161.417" x 149.6"
CSGW 0100-1375-1500	1	-	1.400 mm 55.118"	1.300 mm 51,181"	4.100 x 3.460 mm 161.417" x 136.22"
CSGW 0100-1375-2000	1	-	1.900 mm 74.8"	1.300 mm 51,181"	4.100 x 4.460 mm 161.417" x 175.59"
<b>3</b> CSGW 0200-600-1200	2	600 mm 23.622"	1.100 mm 43.307"	2 x 600 mm / 1 x 1.300 mm 2 x 23.622" / 1 x 51,181"	4.100 x 2.860 mm 161.417" x 112.598"
<b>1</b> CYCW 0600-1180-1500	6	1.180 mm 46.456"	1.400 mm 55.118"	6 x 700 mm 6 x 27.559"	8.900 x 3.600 mm 350.393" x 141.732"
<b>3</b> CYGW 0800-800-1000	8	800 mm 31.496"	900 mm 35.433"	8 x 800 mm 8 x 31.496"	9.275 x 2.460 mm 365.157" x 96.85"
<b>2</b> CZBW 1100-750-1200	11	750 mm 29.527"	900 mm 35.433"	11 x 750 mm 11 x 29.527"	12.700 x 2.860 mm 500" x 112.598"
<b>2</b> CZCW 0400-1800-1500	4	1.800 mm 70.866"	1.200 mm 47.244"	4 x 1.800 mm 4 x 70.866"	13.000 x 3.460 mm 511.811" x 136.22"
<b>2</b> CZCW 0800-900D-1500	8	900 mm 35.433"	1.200 mm 47.244"	8 x 900 mm / 4 x 1.800 mm 8 x 35.433" / 4 x 70.866"	13.000 x 3.460 mm 511.811" x 136.22"
CZCW 0800-900D-2000	8	900 mm 35.433"	1.900 mm 74.8"	8 x 900 mm / 4 x 1.800 mm 8 x 35.433" / 4 x 70.866"	11.560 x 4.460 mm 455.118" x 175.59"

**1** Pull Through System - Roll to Roll - back to front

**2** Pull Through System - Roll to Roll - left to right

**3** System on Request

## Combi Head - F +W

Machine	No of Heads	Head Distance (W-W   F-W)	Working Area Depth	Working Area Width (F+W   W)	Machine Net Size (Length x Depth)
JCZA 0109-550-700	1+1	-   275 mm -   10.82"	600 mm 23.622"	550 mm 21.653"	2.000 x 1.730 mm 78.74" x 68.11"
JGZA 0109-550-700	1+1	-   550 mm -   21.653"	600 mm 23.622"	1.100 mm*   1.100 mm 43.307"   43.307"	3.440 x 1.840 mm 135.433" x 72.44" <b>3</b>
CSGZ 0109-825-1200	1+1	-   550 mm -   21.653"	1.100 mm 43.3"	825 mm   1.300 mm 32.48"   51,181"	4.100 x 2.860 mm 161.417" x 112,598"
CSGZ 0109-825-2000	1+1	-   550 mm -   21.653"	1.900 mm 74.8"	825 mm   1.300 mm 32.48"   51,181"	4.100 x 4.460 mm 161.417" x 175,590"
CYGZ 0809-800-1000	8+8	800 mm   350 mm 31.496"   13.779"	900 mm 35.433"	800 mm 31.496"	9.275 x 2.460 mm 369.09" x 96.85" <b>3</b>
CZCZ 0809-900-1500	8+8	900 mm   450 mm 35.433"   17.716"	1.400 mm 55.118"	900 mm   1.800 mm 35.433"   70.866"	11.560 x 3.460 mm 455.118" x 136.22"
CZCZ 0809-900-2000	8+8	900 mm   450 mm 35.433"   17.716"	1.900 mm 74.8"	900 mm   1.800 mm 35.433"   70.866"	11.560 x 4.460 mm 455.118" x 175.59" <b>3</b>

## Combi Head - F + K

Machine	No of Heads	Head Distance (K-K   F-K)	Working Area Depth	Working Area Width	Machine Net Size (Length x Depth)
JCHA 0109-550-700	1+1	-   275 mm -   10.82"	700 mm 27.559"	550 mm 21.653"	2.000 x 1.730 mm 78.74" x 68.11"

## Combi Head - F + K + W

Machine	No of Heads	Head Distance (F-F   F-K   K-W)	Working Area Depth	Working Area Width (F+K+W   W)	Machine Net Size (Length x Depth)
JGVA 0109-550-700	1+1+1	-   275 mm   275 mm -   10.82"   10.82"	600 mm 23.622"	1.100 mm*   1.100 mm 43.307"   43.307"	3.440 x 1.840 mm 135.433" x 72.44"
CSGV 0109-825-1000	1+1+1	-   275 mm   275 mm -   10.82"   10.82"	900 mm 35.433"	825 mm   1.300 mm 32.48"   51,181"	4.100 x 2.460 mm 161.417" x 96.85"

## F - Head

Machine	No of Heads	Head Distance	Working Area Depth	Working Area Width	Machine Net Size (Length x Depth)
SPRINT 6 - LED	1	-	220 mm 8.66"	420 mm 16.535"	1.040 x 985 mm 40.944" x 38.779"

\* W-Head layer foot must be witched up



# ABOUT

**ZSK Technical Embroidery Systems is a division of ZSK Stickmaschinen GmbH, the leading German manufacturer of industrial embroidery machines „Made in Germany“.**

With great expertise and experience in the textile machine construction, the company from the Lower-Rhine area has developed a broad range of applications for its embroidery machines.

Beside large machines for the challenges at the mass production and embroidery machines to individualize textiles, ZSK Stickmaschinen GmbH manufactures machines for laying and fixing fibres, wires and tubes, the so-called TECHNICAL EMBROIDERY SYSTEMS.

ZSK has been shaped this sector with the development of customized embroidery solutions since the 1990's.

Today ZSK's TECHNICAL EMBROIDERY SYSTEMS enable the free orientated laying of fibers and wires in a 2-dimensional space on flexible carrier material.

TAILORED FIBER PLACEMENT, meaning the laying according to the distribution of forces within a structural component is a major advantage of this process.

With innovative applications like active wire and fiber supply systems for industrial demands, automatic pull-through systems for the carrier material or a wire hit detection system ZSK TECHNICAL EMBROIDERY SYSTEMS achieve a high level of automatization and efficiency.

# SERVICE



## Hotline

Sales and service partner in over 75 countries worldwide will help you when you need it.



## Training Courses

Training courses for customers and partners on location or at ZSK Embroidery Academy, Krefeld or at the Training and Education Centre TEC in Seattle, USA.



## Spare Parts

Guaranteed fast and global delivery and installation for over 10.000 available spare parts.



## Technical Support

Trained experts and technicians that speak your language in more than 75 countries.

Email: [service@zsk.de](mailto:service@zsk.de)



### ZSK TECHNICAL EMBROIDERY SYSTEMS

A DIVISION OF ZSK STICKMASCHINEN

Magdeburger Str. 38 - 40  
47800 Krefeld  
Germany

Online: [www.technical-embroidery.com](http://www.technical-embroidery.com)  
Email: [contact@technical-embroidery.com](mailto:contact@technical-embroidery.com)



[facebook.com/ZSK.Stickmaschinen](https://facebook.com/ZSK.Stickmaschinen)



[twitter.com/zsktechembroid](https://twitter.com/zsktechembroid)



[youtube.com/zskfilm](https://youtube.com/zskfilm)

### Picture Credits

- [1] Hörr, M.; Gries, T.; Jockenhövel, S.: Sticken zur Funktionalisierung von Textilien. TVP : Fachzeitschrift für Textilveredlung und Promotion (2015), H. 4, S. 58-61
- [2] Wearable Life Science GmbH, Frankfurt am Main, Germany

ZSK - DIE STICKMASCHINE.